



SHUTTLE LT

# **PIVOT SHUTTLE LT**

## *Original Operational Instructions*

This manual is intended to provide you with the information needed to get you on the trail, walk you through the steps necessary to set up all the components, and become familiar with the Shimano STEPS E-bike System. This document contains some helpful diagrams and reference material to make sure you have everything necessary to maintain your Shuttle LT and enjoy it to the fullest.



| <b>TABLE OF CONTENTS</b>                          |  | <b>PAGE</b> |
|---|--|-------------|
| <b>1. Quick Start Guide</b>                       |  | <b>1</b>    |
| - Suspension/Tire Set-up                          |  | 1           |
| - Adjusting Saddle Height                         |  | 1           |
| - Charging the Battery                            |  | 1           |
| - Powering the System ON and OFF                  |  | 1           |
| - Assist Switch and Shifter Function              |  | 2           |
| - Operating the Cycle Computer                    |  | 2           |
| - Screen Display                                  |  | 2           |
| <b>2. Bike Set-up</b>                             |  | <b>3</b>    |
| - Setting Proper Sag                              |  | 3           |
| - Setting Compression Damping on the Fox Float X  |  | 3           |
| - Setting Open Mode Adjust on the Fox Float X     |  | 3           |
| - Setting Rebound Damping on the Fox Float X      |  | 4           |
| - Setting Air Pressure on the Fox 38 Forks        |  | 4           |
| - Setting Compression Damping on the Fox 38 Forks |  | 5           |
| - Setting Rebound Damping on the Fox 38 Forks     |  | 5           |
| - Recommended Tire Pressure                       |  | 5           |
| <b>3. Charging</b>                                |  | <b>6</b>    |
| - Charging the Battery                            |  | 6           |
| - Charger LED Lamp                                |  | 6           |
| - USB-C Charging on the Shuttle LT                |  | 6           |
| - Battery Removal and Installation                |  | 7           |
| <b>4. Shimano STEPS System</b>                    |  | <b>8</b>    |
| - Connecting to E-Tube Project App                |  | 8           |
| - Main Menu for E-Tube Project                    |  | 8           |
| - Customize Menu in E-Tube Project                |  | 8           |
| - Assist Profiles in E-Tube Project               |  | 9           |
| - Update Firmware Menu in E-Tube Project          |  | 9           |
| - Maintenance Menu in E-Tube Project              |  | 9           |
| <b>5. Troubleshooting</b>                         |  | <b>10</b>   |
| - Cycle Computer Warning Codes                    |  | 10          |
| - Cycle Computer Error Codes                      |  | 11          |
| <b>6. Schematics</b>                              |  | <b>12</b>   |
| - Shimano STEPS Schematic                         |  | 12          |
| - Small Parts Schematic                           |  | 13          |
| - Small Parts Table                               |  | 14          |
| - Wiring Diagrams                                 |  | 15          |
| <b>7. Additional Information</b>                  |  | <b>16</b>   |
| - Shimano STEPS System                            |  | 16          |
| - Pivot Shuttle LT                                |  | 16          |
| - Bicycle Safety                                  |  | 16          |
| - Battery Safety                                  |  | 16          |
| - Sources   |  | 18          |

This "Quick Start Guide" provides the essential information to set up your bike.

## Suspension/Tire Set-up

| COMPONENT  |                               | QUICK START SETTING   |
|--|-------------------------------|---|
| Shock Air Pressure<br>(by Body Weight)<br><i>*Always Check Sag</i> | Body Weight in [kg] to [bar]  | $0.15 \times \text{Body Weight [kg]} + 0.7$ [bar]               |
|  | Body Weight in [kg] to [psi]  | $2.2 \times \text{Body Weight [kg]} + 10$ [psi]                 |
|  | Body Weight in [lbs] to [bar] | $0.07 \times \text{Body Weight [lbs]} + 0.7$ [bar]              |
|  | Body Weight in [lbs] to [psi] | Body Weight [lbs] + 10 [psi]                                    |
| Shock Compression Damping  |                               | <b>8 clicks in from OPEN*</b>                                   |
| Shock Rebound Damping  |                               | 6 clicks in from OPEN   |
| Fork Air Pressure  |                               | 80 [psi] / 5.52 [bar]   |
| Fork Compression Damping   |                               | <b>HSC: 2 clicks in from OPEN*</b> ; LSC: 5 clicks in from OPEN |
| Fork Rebound Damping   |                               | <b>HSR: 3 clicks in from OPEN*</b> ; LSR: 7 clicks in from OPEN |
| Front Tire Pressure  |                               | 23 [psi] / 1.58 [bar]   |
| Rear Tire Pressure   |                               | 28 [psi] / 1.93 [bar]   |
| <i>* These Adjustments are not available on all builds.</i>        |                               |   |

## Adjusting Saddle Height

1. Use a 2mm hex wrench, loosen the drive side cable port cap securing the dropper post housing. (fig. 1)
2. Using a 4mm hex wrench, loosen the seat post clamp bolt and raise/lower the saddle to the preferred height.
3. Using a 4mm hex wrench, tighten the seat post clamp bolt to 5 Nm.
4. Tighten the cable port cap screw with a 2mm hex wrench to secure the dropper post housing.

NOTE: If making a large adjustment to saddle height you may need to help feed the housing up past the drive unit into the seat tube. (fig. 2)

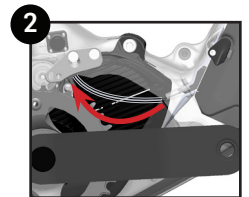
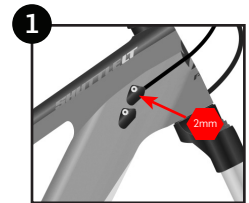

## Charging the Battery

NOTE: The battery does not come fully charged and must be charged completely before the first use.

1. Locate the rubber charging port on the non-drive side of the seat tube. (fig.3)  
Pull back the sealing cover to access the charging terminal.
2. Locate the alignment pin in the charger. Insert the charging cable into the charging terminal, ensuring the cable and terminal are properly aligned. (fig. 4)
3. The display will illuminate briefly when the charger is properly connected. The charger LED lamp will flash red while charging, and glow green when charging is complete.
4. When done charging, remove the cable from the terminal and close the sealing cover.

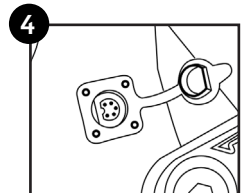
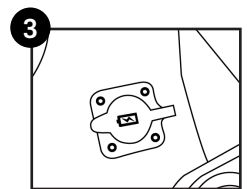

## Powering the System ON and OFF

- The power button is located on the top of the top tube. (fig. 5)
- Power the system on by pressing on the power symbol.
- Power cannot be turned on while the battery is charging.
- If the bike has not moved for 10 minutes, the power will shut off automatically.

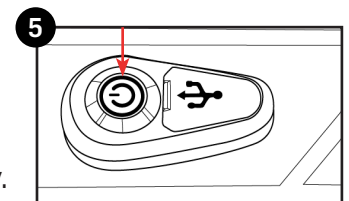

## Assist Switch and Shifter Function

- On start-up, the assist mode will be off. There are three levels of assistance: Eco, Trail, and Boost.
- The switch on the left side of the handle bar controls the level of assistance provided by the system.
- Walk Mode: This provides limited power to help move the bike while walking.
  - Press Y1 until the Assist mode is off, then press and hold Y1 to initiate Walk Mode.

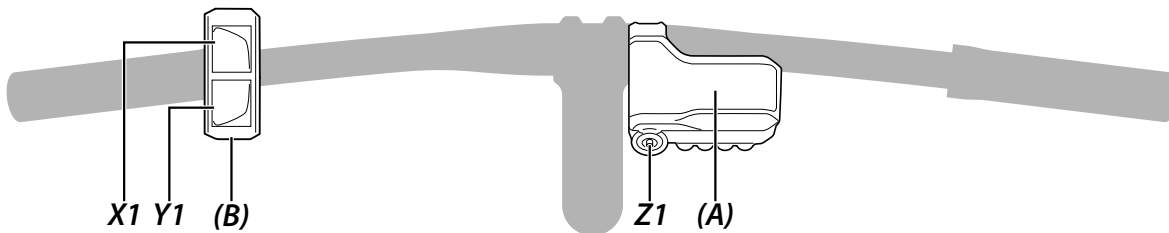

| CYCLE COMPUTER (A) |   |
|--------------------|---|
| <b>Z1</b>          | Cycles through display modes (Current Speed is default and will return after 60 seconds)<br><i>(Display Modes: Distance, Odometer, Range, Travel Time, Avg. Speed, Max. Speed, Cadence, Watts, Calories, Clock)</i> |
| ASSIST SWITCH (B)  |   |
| <b>X1</b>          | Increase the level of assistance (Eco, Trail, and Boost)  |
| <b>Y1</b>          | Decrease the level of assistance (Press and hold for WALK mode)   |

## Operating the Cycle Computer

- The following settings can be adjusted through the cycle computer:

| MENU                    |                                 |
|-------------------------|---------------------------------|
| <b>Clear</b>            | Clear Odometer                  |
| <b>Clock</b>            | Set current time                |
| <b>Brightness</b>       | Adjust Display Brightness (1-5) |
| <b>Beep</b>             | Toggle Display Sound            |
| <b>Unit</b>             | Choose Units (km/miles)         |
| <b>Language</b>         | Choose Display Language         |
| <b>Assist Customize</b> | Choose Assist Profile (1 or 2)  |
| <b>Display Speed</b>    | Adjust Display speed            |
| <b>Exit</b>             | Exit the Menu                   |

- Follow the below procedure to adjust the settings in the Menu:
  1. Press and hold Z1 on cycle computer to enter the settings menu.
  2. Using X1 or Y1 scroll to setting to be adjusted. Press Z1 to enter settings options.
  3. Using X1 or Y1 select desired setting adjustment.
  4. Press Z1 to confirm adjustment. This will return to the menu screen.
  5. Using X1 or Y1 scroll to "Exit". Press Z1 to return to the main display.

## Screen Display



| #        | DISPLAY ITEM                 |
|----------|------------------------------|
| <b>1</b> | Battery level indicator      |
| <b>2</b> | Assist Gauge                 |
| <b>3</b> | Assist Mode Display*         |
| <b>4</b> | Current Speed / Display Mode |

\*[ECO] mode automatically activates as remaining battery capacity declines

## Setting Proper Sag

1. Always set sag with the **blue** compression lever to the open position. (fig. 1)
2. If your shock has additional compression and rebound adjustments ensure they are adjusted to be fully open, compression to the softest setting, and rebound to its fastest setting. Do this by rotating them fully counter-clockwise.
3. If it is not installed already, attach the sag indicator to the bottom of the shock body using the provided zip-tie and carefully cut the excess.(fig. 2)
4. Find a level surface and something to steady yourself while mounted on the bike so you can be on the pedals in a seated position. It may be easier to have a partner hold your bike steady from the front, by holding the handlebars while you are in your riding position.
5. While standing on the pedals, sit down hard into the saddle to cycle the suspension well into the stroke. This will ensure the bike comes to rest at the natural sag setting with the rider in the saddle.
6. While in the saddle and not moving, slide the O-ring up into position against the air can. (fig. 3)
7. Once the O-ring is set in place, slowly step off the bike so as not to move the O-ring.
8. Make adjustments to the sag by removing or adding air so that steps 4-7 result in the O-ring lining up with the **red** line on the sag indicator. (fig. 4) When adjusting air pressure in the shock, cycle the shock before re-checking sag, so the large Evol negative air chamber equalizes pressure with the main chamber each time air is added or removed. You can do this by pushing down on the saddle several times to compress the shock past the sag point.

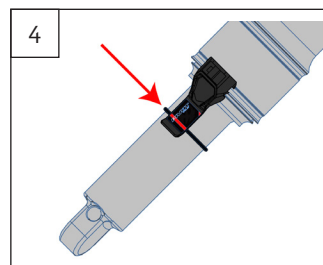
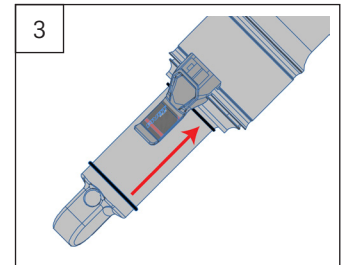
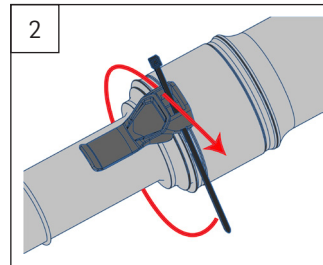
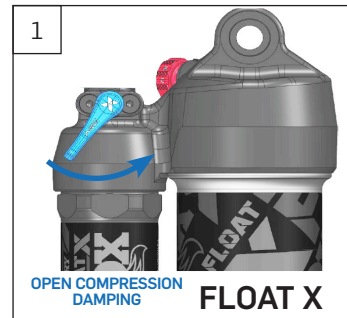

**WARNING:** Make sure the sag indicator does not contact the frame or linkage through the suspension cycle. Otherwise, the indicator may break while riding.

## Setting Compression Damping on the Fox Float X

- Some Factory Series Float X features a **blue** low speed compression adjustment knob, which can be used to fine tune the open mode of the compression damping. This knob offers 10 additional fine tune adjustment settings to the open mode.
- Turning the knob clockwise will increase low speed compression damping. Turning the knob counter-clockwise will decrease low speed compression damping. You can experiment with all of these options to find the setting that provides the best compression support and plushest feel for your weight and riding style.
- For a rider close to 100lbs. we recommend having the compression fully open, by having the knob turned fully counter-clockwise. For riders 200lbs we like to start at 3 clicks in from full closed as a good baseline setting. If the rider's weight is less than 200lbs, open up compression damping 1 click counter-clockwise for every 10lbs. less. For every 10lbs over 200lbs we recommend increasing compression damping by 1 click clockwise.

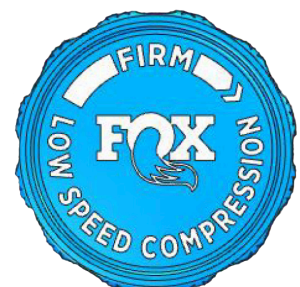

LOW SPEED COMPRESSION KNOB

## Using the Climb Switch on the Fox Float X

- Some Float X shocks feature a two position lever allows for on-the-fly adjustment between fully open and firm for climbing. As with other shocks, the firm setting is best suited for long fire road climbs and smooth XC courses.



2 POSITION LEVER

## Setting Rebound Damping on the Fox Float X

- Rebound is set from the most open (fully counter-clockwise) position.
- The rebound setting is determined by the air pressure in the shock.
- Refer to the table below for the suggested rebound setting. The number in the chart refers to how many clicks in (clockwise) from the open setting the rebound should be set. Fox sets rebound from the closed position, so that has been provided in the table in parentheses.



FLOAT X REBOUND KNOB

| AIR PRESSURE       |                | SUGGESTED REBOUND SETTING FLOAT X |
|--------------------|----------------|-----------------------------------|
| [bar]              | [psi]          |                                   |
| < 8.3              | <120           | <b>1</b> (9)                      |
| <b>8.3 - 9.7</b>   | <b>120-140</b> | <b>2</b> (8)                      |
| <b>9.7 - 11</b>    | <b>140-160</b> | <b>3</b> (7)                      |
| <b>11 - 12.4</b>   | <b>160-180</b> | <b>4</b> (6)                      |
| <b>12.4 - 13.8</b> | <b>180-200</b> | <b>5</b> (5)                      |
| <b>13.8 - 15.2</b> | <b>200-220</b> | <b>6</b> (4)                      |
| <b>15.2 - 16.5</b> | <b>220-240</b> | <b>7</b> (3)                      |
| <b>16.5 - 17.9</b> | <b>240-260</b> | <b>8</b> (2)                      |
| <b>17.9 - 19.3</b> | <b>260-280</b> | <b>9</b> (1)                      |
| <b>19.3 - 20.7</b> | <b>280-300</b> | <b>CLOSED</b>                     |

Clicks from **OPEN** (Clicks from **CLOSED**)

## Setting Air Pressure on the Fox 38 Fork

- Fox recommends setting sag between 15% and 20% of the total fork travel. The Shuttle LT comes with a 170mm fork, so the proper sag measurement is 25.5 - 34.0mm.
- The air pressure in the Fox 38 fork should not exceed 8.3 [bar] (120 [psi]).
- To achieve the proper sag, reference the chart below for an initial starting point.

| RIDER WEIGHT     |                  | FOX 38 AIR PRESSURE   |
|------------------|------------------|-----------------------|
| [kg]             | [lbs]            |                       |
| <b>55 - 59</b>   | <b>120 - 130</b> | 64 [psi] / 4.4 [bar]  |
| <b>59 - 64</b>   | <b>130 - 140</b> | 68 [psi] / 4.7 [bar]  |
| <b>64 - 68</b>   | <b>140 - 150</b> | 72 [psi] / 5.0 [bar]  |
| <b>68 - 73</b>   | <b>150 - 160</b> | 76 [psi] / 5.2 [bar]  |
| <b>73 - 77</b>   | <b>160 - 170</b> | 80 [psi] / 5.5 [bar]  |
| <b>77 - 82</b>   | <b>170 - 180</b> | 84 [psi] / 5.8 [bar]  |
| <b>82 - 86</b>   | <b>180 - 190</b> | 89 [psi] / 6.1 [bar]  |
| <b>86 - 91</b>   | <b>190 - 200</b> | 93 [psi] / 6.4 [bar]  |
| <b>91 - 95</b>   | <b>200 - 210</b> | 97 [psi] / 6.7 [bar]  |
| <b>95 - 100</b>  | <b>210 - 220</b> | 102 [psi] / 7.0 [bar] |
| <b>100 - 105</b> | <b>220 - 230</b> | 106 [psi] / 7.3 [bar] |
| <b>105 - 109</b> | <b>230 - 240</b> | 110 [psi] / 7.6 [bar] |
| <b>109 - 114</b> | <b>240 - 250</b> | 114 [psi] / 7.9 [bar] |





## Setting Compression Damping on the Fox 38 Grip 2 Fork

- To set compression, start from the open (or fastest) position by turning the *black* (LSC) dial & *blue* (HSC) dial counterclockwise until they stop clicking.
- A good starting point for most riders is to turn the *black* (LSC) dial clockwise 5 clicks & turn the *blue* (HSC) dial clockwise 2 clicks.
- The recommended starting points may need to be adjusted based on rider weight. Lighter riders may prefer less compression damping (fewer clicks from open).



GRIP2 Compression Knob

## Setting Compression Damping on the Fox 38 Grip Fork

- We always start with the lever in the full open position. Most riders will not need to make any changes from this position.
- If you do need more compression support, the lever will provide a low speed compression adjustment until the lever is turned halfway.
- The second half of the lever adjustment affects the high speed compression circuit. Of course, fully closed provides a nearly locked out feel for climbing.



GRIP Compression Knob

## Setting Rebound Damping on the Fox Fork 38

- Remove the protective cover over the rebound knobs on the lower fork leg.
- To set rebound, start from the open (or fastest) position by turning the *red* rebound dial(s) on the bottom of the right fork leg counterclockwise until it stops clicking. On the Fox 38 Grip 2 there are two dials. One for high speed and one for low speed.
- Refer to the chart below for the recommended settings when setting rebound. Fox clicks are in parentheses.

| RIDER WEIGHT  | FOX 38 SUGGESTED REBOUND |                                  |
|---------------|--------------------------|----------------------------------|
|               | LSR / HSR                | *HSR not available on all builds |
| 120-130 [lbs] | 3 / Open                 | (12 / 10)                        |
| 130-140 [lbs] | 4 / Open                 | (11 / 10)                        |
| 140-150 [lbs] | 5 / 1                    | (10 / 9)                         |
| 150-160 [lbs] | 6 / 2                    | (9 / 8)                          |
| 160-170 [lbs] | 7 / 3                    | (8 / 7)                          |
| 170-180 [lbs] | 8 / 4                    | (7 / 6)                          |
| 180-190 [lbs] | 8 / 4                    | (7 / 6)                          |
| 190-200 [lbs] | 9 / 5                    | (6 / 5)                          |
| 200-210 [lbs] | 9 / 5                    | (6 / 5)                          |
| 210-220 [lbs] | 10 / 6                   | (5 / 4)                          |
| 220-230 [lbs] | 11 / 7                   | (4 / 3)                          |
| 230-240 [lbs] | 11 / 7                   | (4 / 3)                          |
| 240-250 [lbs] | 12 / 8                   | (3 / 2)                          |

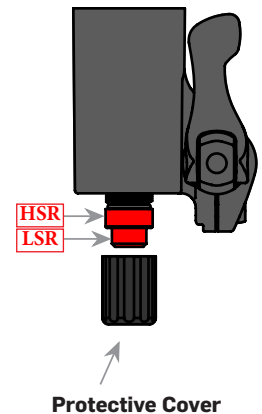

Protective Cover

Clicks from OPEN (Clicks from CLOSED)

## Recommended Tire Pressure

- Tire pressure is an important factor on having the bike ride properly. If the tire pressure is too high, the tire will not conform to ground, reducing traction. If the tire pressure is too low, the tire could pinch flat.
- It is important to have an accurate pressure gauge when setting tire pressure; preferably a digital gauge with a 0.03 [bar] (0.5 [psi]) accuracy.
- The recommended tire pressure will vary slightly based on rider weight, riding style, and terrain.
- Some riders may find it helpful to start a ride at a slightly higher pressure than recommended and let out a little air throughout the course of the ride until you find your ideal riding tire pressure.

| RECOMMENDED TIRE PRESSURE |                       |
|---------------------------|-----------------------|
| FRONT                     | REAR                  |
| 1.58 [bar] / 23 [psi]     | 1.93 [bar] / 28 [psi] |



## Charging the Battery on the Bike

**NOTE:** The battery does not come fully charged and must be charged completely before the first use.

1. Locate the rubber charging port on the non-drive side of the seat tube. (fig. 1)
2. Pull back the sealing cover to access the charging terminal. (fig. 2)
3. Locate the alignment pin in the charger. Insert the charging cable into the charging terminal, ensuring the cable and terminal are properly aligned. (fig. 3)
4. The display will illuminate briefly when the charger is properly connected. The charger LED lamp will glow red while charging, and glow green when charging is complete.
5. When done charging, remove the cable from the terminal and close the sealing cover.

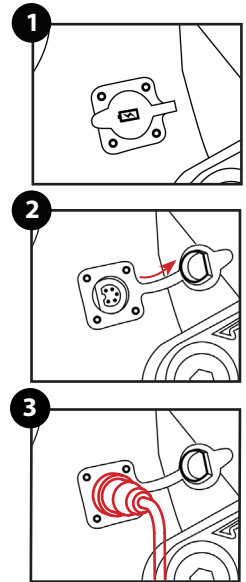

## Charger LED Lamp

- After charging has started, the LED lamp on the charger lights up.

### Charger LED Lamp

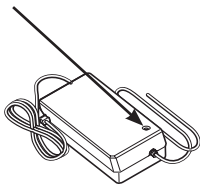

| LED INDICATOR  | DESCRIPTION                                      |                      |
|--|--|----------------------|
| <b>Lit Up (GREEN)</b>  | Battery unconnected or Battery Charging Complete |                      |
| <b>Lit Up (RED)</b>  | Initial Battery Charging                         |                      |
| <b>Flashing (RED)<br/>The state of charge (SOC) is indicated by the LED flashing sequence</b>                          | 1 flash SOC < 20%                                | 2 flashes SOC 20-39% |
|  | 3 flashes SOC 40-59%                             | 4 flashes SOC 60-79% |
|  | 5 flashes SOC > 80%                              |                      |
| <b>Flashing (ORANGE)*</b>  | Charging Failure                                 |                      |
| <b>* Remove AC Power and plug-in again. If symptoms still occur take your bike and charger to a authorized dealer.</b> |  |                      |

## USB-C Charging on the Shuttle LT

- The power button also houses a USB-C port for accessory charging.
- Lift up on the USB cover to access the charging port. (fig. 4)
- When not using the charging port replace the cover.

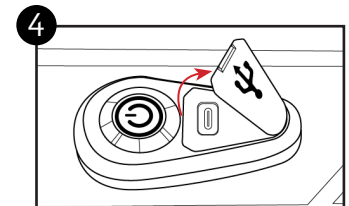

## Charging the Battery off the Bike

1. Remove the battery from the bike. Instructions for this procedure can be found below.
2. Look for the alignment pin in the charger and insert the charging cable into the charging adapter, ensuring the cable and adapter are properly aligned.
3. Secure the cable to the adapter.
4. Orient the adapter terminals with the terminal block on the battery and plug the adapter into the battery.
5. The charger LED lamp will glow red while charging, and glow green when charging is complete. The current charge level will be displayed on the battery LEDs just above the terminal block on the battery.
6. When done charging, remove the adapter from the battery terminal block.

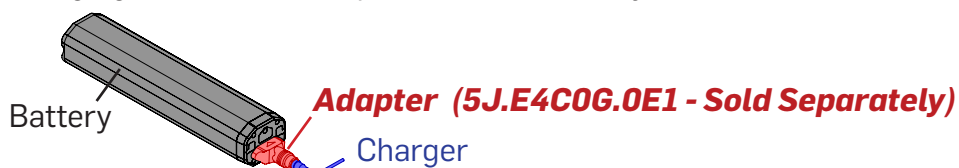

## Removing the Battery

- The battery may need to be removed to swap batteries or to charge the battery if there is no power supply near the bike.

*NOTE: If the bike is sitting level on its wheels the battery will touch the ground before it is removed from the frame. Using a stand to secure the frame and elevate the rear wheel is recommended.*

- Using a M5 hex wrench, remove the front two bolts securing the skid plate to the frame. (fig. 1)
- Rotate the cover toward the rear of the bike. (fig. 2)
- Carefully remove the power cord from the battery. (fig. 3)
- Use both hands to grip the battery and gently guide it down and out of the frame. (fig. 4)
- If you are not using a stand to hold the rear wheel off the ground you may need to tip the bike to the non-drive side or lift it up to remove the battery completely from the frame.

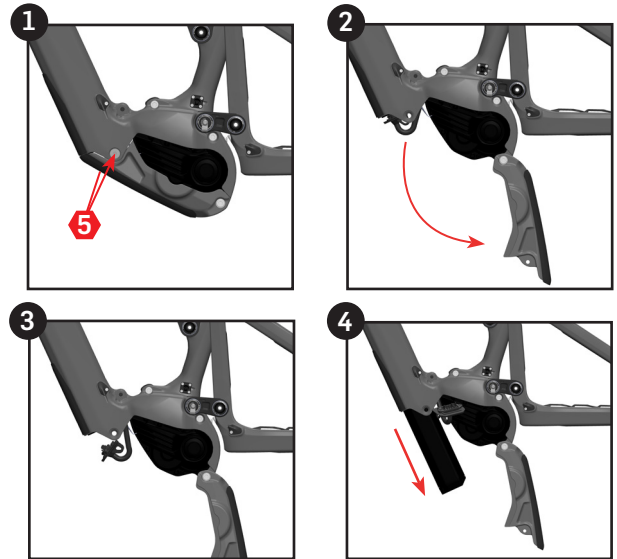

## Installing the Battery

- To install the battery, reverse the removal procedure from above.

*NOTE: Installing the battery can be easier with the bike upside-down or on its side. Using a stand to secure the bike upside-down is recommended.*

- Check the orientation of the battery before installing the battery. (fig. 5)
- Carefully route the battery back into the downtube using both hands. (fig. 6)
- Apply upward pressure on the battery to fully seat the battery into the terminal block (fig. 7)
- Plug the power cord back into the battery. (fig. 8)
- Close the skid plate. (fig. 9)
- Apply Loctite 243 or an equivalent to the thread of the skid plate bolts.
- Re-install the bolts and torque them to 13 Nm. (fig.10)

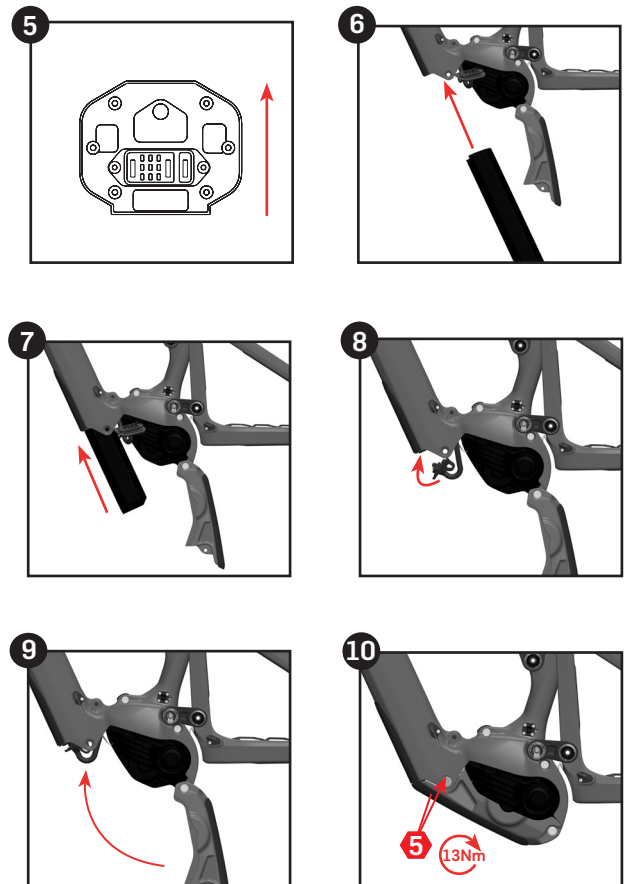

## Connecting to E-Tube Project App

- The display layout and switch operation can be customized through the Shimano E-Tube Project App.
- The Shimano E-Tube Project can be accessed via the Shimano E-Tube Project app available in the App Store.
- The E-Tube Project app is compatible with both Android and Apple devices.

Connecting via the E-Tube Project app:

1. Before setting up a connection, turn on the Bluetooth connectivity of the smart phone or tablet.
2. Open the E-Tube Project app and then power up the Shuttle LT.
3. Once the bike has been powered on, press the large plus sign (+) on the "Get started" opening screen.
4. A list of nearby devices will be listed on the screen. Choose your bike.
5. When the connection is successful, a list of "confirmed units" will appear. These are all the devices connected to the Shuttle LT. The units listed should include: the battery, drive unit, cyclecomputer, & assist switch.
6. If all the connected units appear, press "OK" to confirm that all devices are shown.
7. To disconnect, press the "Disconnect" button at the bottom of the screen.

## Main Menu for E-Tube Project

- The main menu to the E-Tube Project has three main menus that are relevant for the consumer to know how to navigate and operate: Update, Customize, & Maintenance. These are listed at the top of the app.
- The app will open to the "Customize" menu. The other functions can be accessed by swiping left or right.

## Customize Menu in E-Tube Project

- The Customize menu lists the components available for customization: Assist, Drive Unit, Assist Switch, & Cyclecomputer
- The tables below show the available options within the Customize menu.

| E-BIKE            |                   | DESCRIPTION   |
|-------------------|-------------------|---|
| <b>Assist*</b>    | Assist Character  | Adjust Assist Character for each Assist Level (Eco, Trail, Boost)                   |
|                   | Max. Torque       | Adjust Maximum Torque for each Assist Level (Eco, Trail, Boost)                     |
|                   | Assist Start      | Adjust how quickly assistance is provided for each Assist Level (Eco, Trail, Boost) |
| <b>Drive Unit</b> | Max. Assist Speed | Adjust Max Assist Speed (Max. 20 mph) & Speed correction percentage                 |
|                   | Display Speed     | Allows adjustment of display speed to match speed shown on third party unit         |

\*Assist features can be saved into 2 profiles for easy access to preferred settings

| SWITCH                |    | DESCRIPTION   |
|-----------------------|----|---|
| <b>Assist Switch*</b> | X1 | Customize the functions of the buttons on the assist switch |
|                       | Y1 | Customize the functions of the buttons on the assist switch |







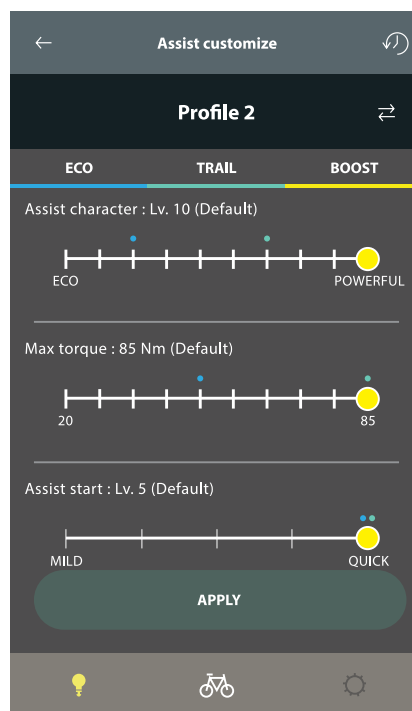
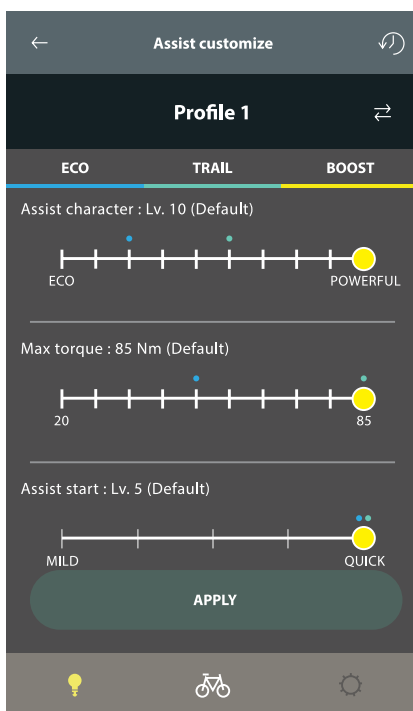

\*X1/Y1 Buttons are the Upper/Lower button on the Assist Switch. See Page 2 for the handlebar diagram.

| DISPLAY              |                  | DESCRIPTION   |
|----------------------|------------------|---|
| <b>Cyclecomputer</b> | Unit             | Change display units from International standards to US Customary standards |
|                      | Shift            | Toggle display modes (Travel Time, Avg. Speed, Max. Speed, Cadence, Time)   |
|                      | Time (Auto/Man.) | Set the current time (Either manually or automatically)                     |
|                      | Beep             | Toggle system sound   |
|                      | Brightness       | Adjust display brightness   |
|                      | Language         | Select display language   |
|                      | Name             | Create a custom name for your bike  |
|                      | Passkey          | Change passkey for accessing the E-Tube app                                 |

## Assist Profiles in E-Tube Project

- The E-Tube Project allows saving two profiles with different assist characteristics for different terrain.
- To customize a profile:
  1. Under the "Customize" menu, select "Assist". (The active profile will be displayed on this button.)
  2. At the top of the "Assist customize" screen, the current profile will be displayed. To choose the other profile, tap the profile name (or the double arrows) and it will alternate to the other profile.
  3. To customize the selected profile, choose "Eco", "Trail", or "Boost" to customize each assistance level.
  4. For each assistance level, the Assist Character, Max. Torque, & Assist Start features can be customized within the range defined by the white slider. Move the colored dot (corresponding to the selected assistance level), to the desired value for that feature.
- The Shuttle LT comes with two preloaded profiles:
  1. Pivot Factory Default: Optimized for balance and control
  2. Maximum assistance permitted for all levels



-  Return to Customize menu
-  Reset to Default settings
-  Switch between profiles
-  ECO settings
-  TRAIL settings
-  BOOST settings
-  Go to "Update" menu
-  Go to "Customize" menu
-  Go to "Maintenance" menu

## Update Firmware Menu in E-Tube Project

- There is an "Update" menu option listed at the top of the app home screen. To access this feature tap on the word "Update".
- Under the Update menu option, all connected devices are listed, and the app will display if they are running the latest firmware, or if it needs to be updated.
- There is also an "Update All" button. By pressing this button, the software automatically searches for and downloads any update for the system.
- Once the program has completed any updates, each component of the Shimano STEPS E-bike System will be listed with the corresponding version of the latest firmware for that component.

## Maintenance Menu in E-Tube Project

- There is a "Maintenance" menu option listed at the top of the app home screen. To access this feature tap on the word "Maintenance".
- Under the Maintenance menu option, there is an Error log which will track system errors to provide better insight into system performance and catalogue any previous issues.

## Cycle Computer Warning Codes

- Warnings may appear on the cycle computer display if the system detects an issue.
- The warning code will clear once the issue is resolved.
- If any issues persist after the suggestions below, contact the place of purchase.



| CODE          | ISSUE  | OPERATIONAL RESTRICTION                                  | REMEDY   |
|---------------|--|--|--|
| <b>W010</b>   | Drive unit operation temperature is higher than normal         | Power assistance may be lower than usual                 | Stop using the assist function until the drive unit temperature drops          |
| <b>W011</b>   | Traveling speed cannot be detected                             | Maximum speed may be lower than usual                    | Check that the speed sensor is installed correctly                             |
| <b>W013</b>   | Torque sensor was not initialized properly                     | Power assistance may be lower than usual                 | Turn the power off and back on again   |
| <b>W020</b>   | Battery operation temperature is higher than normal            | No system functions will start                           | Leave the battery in a cool place until the temperature decreases sufficiently |
| <b>W032</b>   | Shifting unit installed differs from unit configured in system | Unable to perform gear shifting                          | Update shifting configuration in E-Tube Project app                            |
| <b>W10000</b> | Drive unit operation temperature is higher than normal         | Power assistance may be lower than usual                 | Stop using the assist function until the drive unit temperature drops          |
| <b>W10100</b> | Traveling speed cannot be detected                             | Maximum speed may be lower than usual                    | Check that the speed sensor is installed correctly                             |
| <b>W103</b>   | Sensor initialization could not be completed normally          | Power assistance may be lower than usual                 | Turn the cranks in reverse two or three times                                  |
| <b>W10300</b> | Sensor initialization could not be completed normally          | Power assistance may be lower than usual                 | Turn the cranks in reverse two or three times                                  |
| <b>W104</b>   | Power was turned off due to current leakage detected           | Power assistance will not be provided while riding       | Remove components from drive unit and turn on to find faulty component         |
| <b>W10400</b> | Power was turned off due to current leakage detected           | Power assistance will not be provided while riding       | Remove components from drive unit and turn on to find faulty component         |
| <b>W10500</b> | Unexpected power disconnection was detected                    | There are no restricted assist functions while displayed | Check the power cord for damage. Turn the power off and back on again          |
| <b>W20000</b> | Battery operation temperature is higher than normal            | No system functions will start                           | Leave the battery in a cool place until the temperature decreases sufficiently |
| <b>W30200</b> | Shifting unit installed differs from unit configured in system | Unable to perform gear shifting                          | Update shifting configuration in E-Tube Project app                            |

## Cycle Computer Error Codes

- An error message may appear on the cycle computer if the system detects an issue.
- If any issues persist after the suggestions below, contact the place of purchase.



| CODE                           | ISSUE   | OPERATIONAL RESTRICTION                        | REMEDY   |
|--------------------------------|---|--|--|
| <b>E010</b>                    | A system abnormality was detected in the drive unit                   | Power assistance is not provided during riding | Turn the power off and back on again   |
| <b>E01000 - E01004</b>         | A sensor abnormality was detected in the drive unit                   | Power assistance is not provided during riding | Contact the place of purchase  |
| <b>E01010 - E01011</b>         | A sensor abnormality was detected in the drive unit                   | Power assistance is not provided during riding | Contact the place of purchase  |
| <b>E01020 - E01022</b>         | A sensor abnormality was detected in the drive unit                   | Power assistance is not provided during riding | Contact the place of purchase  |
| <b>E01030</b>                  | A sensor failure was detected in the drive unit                       | Power assistance is not provided during riding | Contact the place of purchase  |
| <b>E01040 - E01042</b>         | A malfunction was detected in the drive unit                          | Power assistance is not provided during riding | Contact the place of purchase  |
| <b>E01050 - E01051</b>         | A sensor failure was detected in the drive unit                       | Power assistance is not provided during riding | Contact the place of purchase  |
| <b>E013, E034 &amp; E03400</b> | An abnormality was detected in the drive unit's firmware              | Power assistance is not provided during riding | Connect to the E-Tube Project app and restore or update the firmware                 |
| <b>E014</b>                    | An abnormal vehicle speed signal was detected from the speed sensor   | Power assistance is not provided during riding | Check that the speed sensor is correctly positioned                                  |
| <b>E020 &amp; E02000</b>       | A communication error between the battery and drive unit was detected | Power assistance is not provided during riding | Check that the cable between the drive unit and battery is properly connected        |
| <b>E021</b>                    | Battery connected to the drive unit is not supported                  | Power assistance is not provided during riding | Turn the power off and back on again   |
| <b>E022</b>                    | The battery connected does not conform with system standards          | No system functions will start                 | Turn the power off and back on again   |
| <b>E023</b>                    | An electrical failure was detected inside the battery                 | No system functions will start                 | Turn the power off and back on again   |
| <b>E025</b>                    | The battery does not recognize the drive unit                         | No system functions will start                 | Confirm the drive unit is compatible. Check the power cord for damage                |
| <b>E030</b>                    | Shifting unit installed differs from unit configured in system        | Power assistance is not provided during riding | Update shifting configuration in E-Tube Project app                                  |
| <b>E033</b>                    | Current firmware is not supported by this system                      | Power assistance is not provided during riding | Connect to the E-Tube Project app and update the firmware                            |
| <b>E035 &amp; E03500</b>       | An abnormality was detected in the vehicle settings                   | Power assistance is not provided during riding | Connect to the E-Tube Project app to check if the settings and vehicle status differ |
| <b>E043</b>                    | Part of the system firmware may be corrupted                          | Power assistance is not provided during riding | Contact the place of purchase to restore the system firmware                         |
| <b>E044</b>                    | Error caused by system configuration                                  | Power assistance is not provided during riding | Contact the place of purchase  |
| <b>E050 &amp; E05000</b>       | An abnormal vehicle speed signal was detected from the speed sensor   | Power assistance is not provided during riding | Check that the speed sensor is correctly positioned                                  |

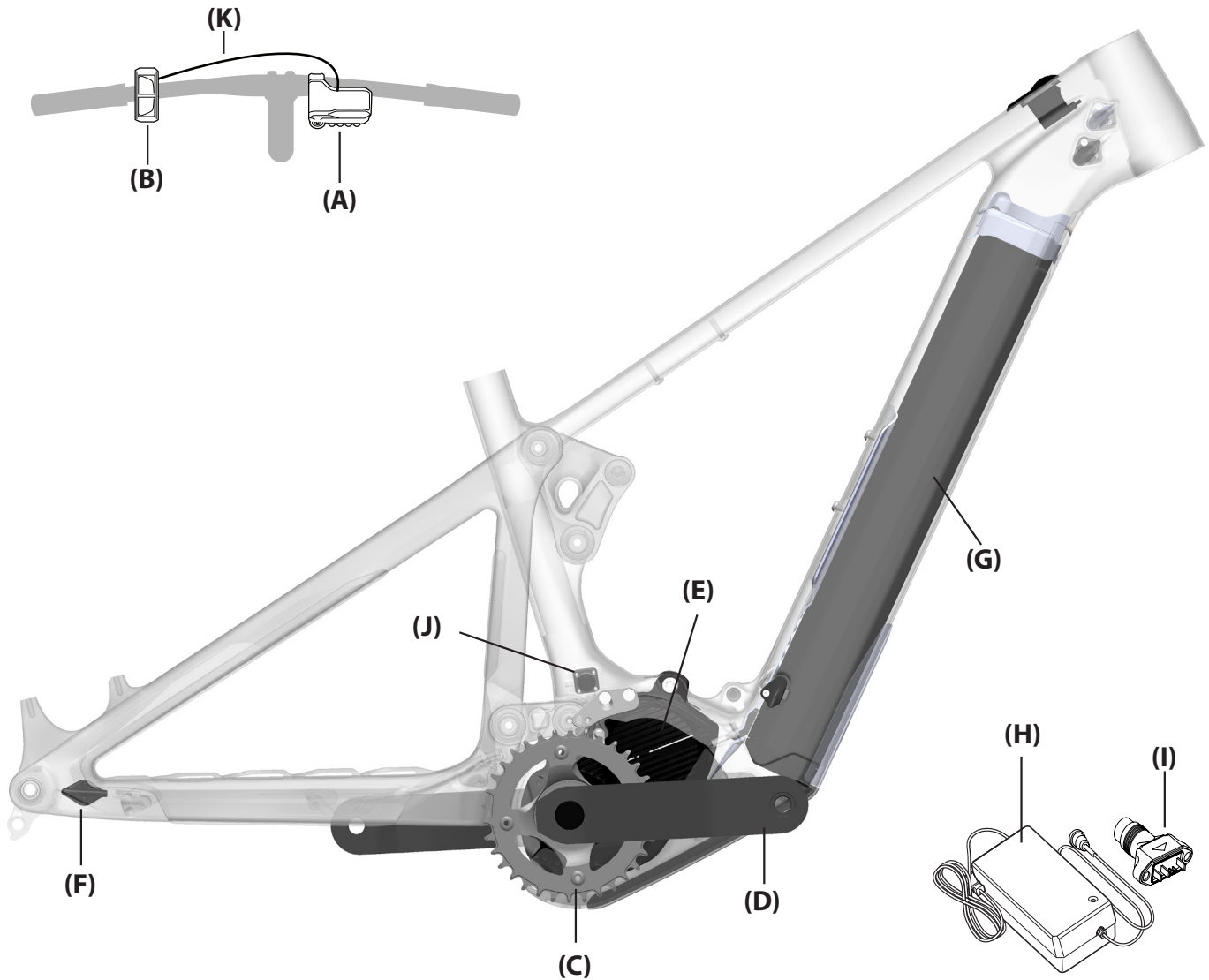

**Shimano STEPS E-bike System Schematic**

| LETTER | PART DESCRIPTION  | PART NAME                                  |
|--------|---|--|
| A      | Cycle Computer  | SC-EM800A                                  |
| B      | Assist Switch   | SW-EM800-L                                 |
| C      | Front Chainring   | SAMOX NWP201-34T                           |
| D      | Crank Arm   | FC-M8150                                   |
| E      | Drive Unit  | DU-EP800                                   |
| F      | Speed Sensor  | EW-SS301                                   |
| G      | Battery   | DARFON 756 Wh                              |
| H      | Battery Charger (US)<br>Battery Charger (EU)                              | DARFON BK.01240.304<br>DARFON BK.01240.301 |
| I      | Battery Charger Adapter (For Off-the-bike Charging - Sold Separately)     | DARFON 5J.E4C0G.0E1                        |
| J      | Charging Port and Cable   | DARFON 5J.E4C0G.0C1                        |
| K      | Assist Switch E-Tube Wire (400mm)   | EW-SD400                                   |
| L      | Cycle Computer E-Tube Wire (S/M/L 1000mm, XL 1200) <i>Not Shown Above</i> | EW-SD1000 / EW-SD1200                      |

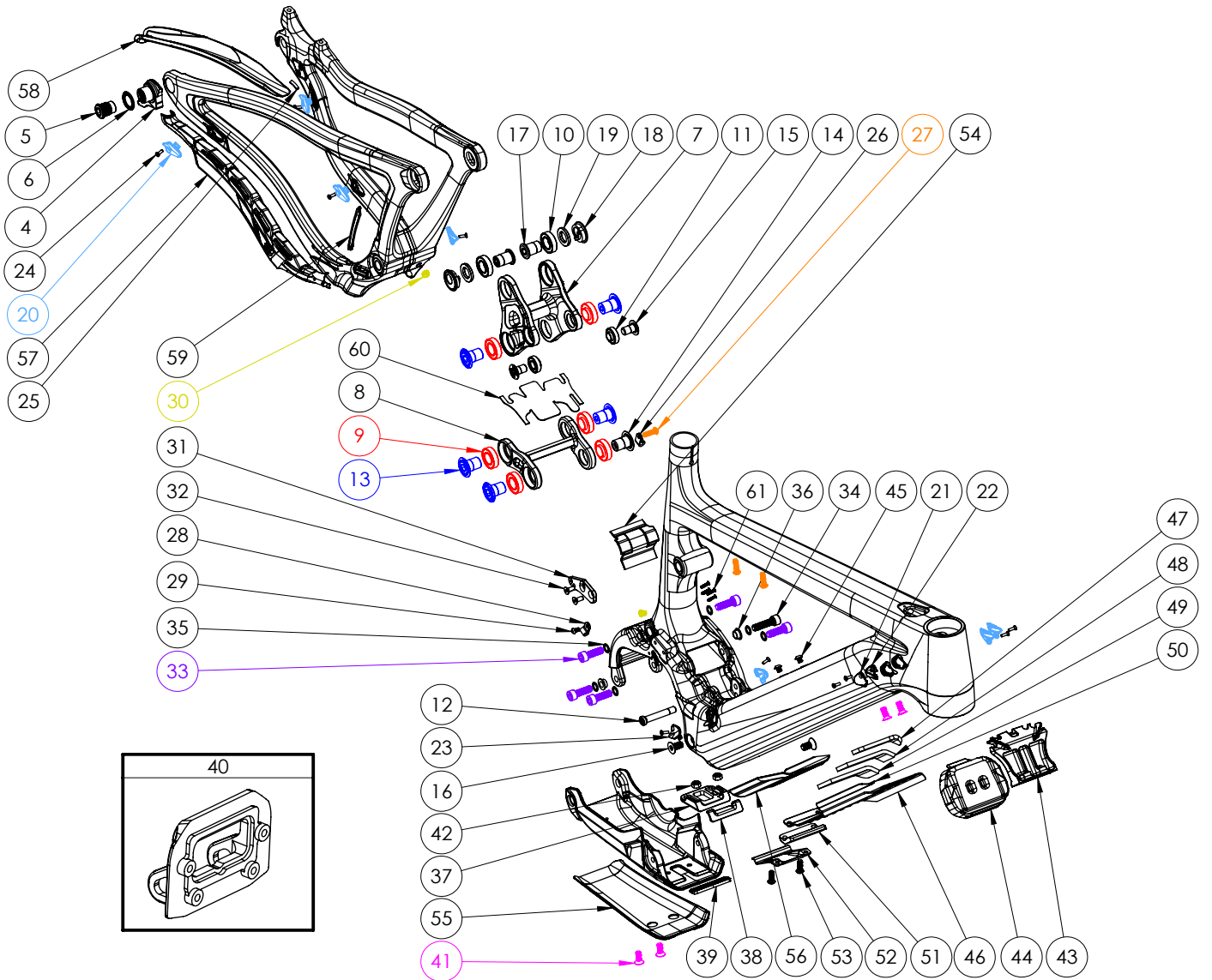

**Small Parts Schematic**

## Small Parts Table

| SHUTTLE LT |  |   |                  |       |
|------------|--|---|------------------|-------|
| Hardware   |  |   |                  |       |
| NUMBER     | PART NUMBER  | DESCRIPTION   | TORQUE           | *     |
| 4          | FP-UDH-TA-12MM-BLK-V1-R1                           | Universal Rear Derailleur Hanger                      |                  |       |
| 5          | -  | Universal Rear Derailleur Hanger Bolt                 | 25 Nm (18 lb-ft) |       |
| 6          | -  | Universal Rear Derailleur Hanger Washer               |                  |       |
| 7          | FP-LNK-UL-84MM-V1-R1                               | 84mm Upper Link                                       |                  |       |
| 8          | FP-LNK-LL-50MM-V2-R1                               | 50mm Out-to-Out Lower Link V2                         |                  |       |
| 9          | FP-BRG-6902-LLUMAXECN                              | 28mm 6902 Extended Max-E Bearing                      |                  | R     |
| 10         | FP-BRG-6902-LLUMAX                                 | 28mm 6902 Standard Max Bearing                        |                  | R     |
| 11         | FP-BRG-6900-LLUMAXE                                | 22mm 6900 Ext'd Max-E Bearing                         |                  | R     |
| 12         | FP-BLT-M8*45.7-BLK-V2                              | M8 Front Shock Bolt for 30.1mm Shock Spacing          | 13 Nm (10 lb-ft) | G / L |
| 13         | FP-BLT-M14*20-BLK-V2-R2                            | M14x20 Link Bolt                                      | 35 Nm (27 lb-ft) | L     |
| 14         | FP-BLT-M14*20-BLK-V4-R1                            | M14x20 Link Bolt w/ Internal Threads                  | 35 Nm (27 lb-ft) | L     |
| 15         | FP-BLT-M10*16.5-BLK-V1                             | M10 Trunnion Mount Bolt                               | 13 Nm (10 lb-ft) | L     |
| 16         | FP-SCW-FLT-M8*16                                   | M8x16 Flat Head Bolts for Skid Plate                  | 13 Nm (10 lb-ft) | G / L |
| 17         | FP-BLT-M14*20-BLK-V3-R2                            | M14x20 Flip Chip Bolt                                 | 35 Nm (27 lb-ft) | L     |
| 18         | FP-NUT-FLIPCHIP-4.6MM-V1                           | 4.6mm Flip Chip                                       |                  | G     |
| 19         | FP-WSH-SPC-15I*250*3W                              | M14x3mm Flip Chip Spacer                              |                  | G     |
| 20         | FP-CLM-MECH-FRM-V1                                 | Internal Routing Cable Clamp                          |                  |       |
| 21         | FP-CVR-MECH-FRM-V2                                 | Internal Routing Hole Cover                           |                  |       |
| 22         | FP-CLM-DUAL-FRM-V1                                 | Internal Routing Dual Clamp                           |                  |       |
| 23         | FP-CLM-MECH-FRM-V2                                 | Internal Routing Cable Clamp (Mirrored)               |                  |       |
| 24         | FP-SCW-FLT-M3*10                                   | M3x10 Cable Clamp Screw (Included w/ Clamp)           |                  |       |
| 25         | FP-CLM-DI2-SLV-BLK-V1                              | Di2 Wire Sleeve for Cable Clamps                      |                  |       |
| 26         | FP-CLM-ADEL-5MM-V1-R1                              | 5mm Adel Clamp for Rear Brake                         |                  |       |
| 27         | PIVOT WB BOLTS V2                                  | M5 Adel Clamp Bolt / Top Tube Tool Bolts              |                  |       |
| 28         | FP-CLM-ADEL-4MM-V1-R1                              | 4mm Adel Clamp for RD Cable                           |                  |       |
| 29         | FP-SCW-BTN-M4*8-V1-R1                              | M4x8 Adel Clamp Mounting Bolt                         |                  |       |
| 30         | FP-GDE-DI2-7*8*2.5*2.5                             | 7x8mm Di2 Wire Guide                                  |                  |       |
| 31         | FP-MNT-CG-V3                                       | Chain Guide Mounting Plate                            |                  |       |
| 32         | FP-SCW-FLT-M5*12                                   | M5x12 CG Mounting Screw                               | 5 Nm (4 lb-ft)   | L     |
| 33         | FP-SCW-SCK-M8*25-V1-R1                             | M8x25 Motor Mounting Screw                            | 13 Nm (10 lb-ft) | L     |
| 34         | FP-SCW-SCK-M8*30-R1                                | M8x30 Motor Mounting Screw                            | 13 Nm (10 lb-ft) | L     |
| 35         | FP-WSH-8I*120*1W                                   | M8 Motor Mount Bolt Washer                            |                  |       |
| 36         | FP-WSH-SKIDPLT-V1-R1                               | M8 Bushing for Rear Skid Plate bolts                  |                  | G     |
| 37         | FP-SPC-SKIDPLT-WEDGE-V1-R1                         | Skid Plate Wedge                                      |                  |       |
| 38         | FP-PRO-SKIDPLT-WEDGE-V1-R1                         | Skid Plate Wedge Rubber                               |                  |       |
| 39         | FP-GDE-BATT-LOWER-V1-R1                            | Lower Battery Support                                 |                  |       |
| 40         | FP-MNT-WIRE-PLATE-V1-R1                            | Wire Connector Custom Backing Plate                   |                  |       |
| 41         | FP-BLT-FLT-M6*16-V1-R1                             | M6x16 Skid Plate Wedge / Front Bracket mounting bolts |                  | G / L |
| 42         | FP-NUT-M6-NYLOC-V1-R1                              | M6 Nylon Locking Nuts                                 |                  |       |
| 43         | FP-MNT-FRNT-BATT-V3-R1                             | Front Battery Bracket                                 |                  |       |
| 44         | FP-MNT-LATCH-BATT-V1-R1                            | Front Battery Catch                                   |                  |       |
| 45         | FP-BLT-BTN-M5*6-V1-R1                              | M5x6 DT Water Bottle Bolts                            | 3 Nm (26 in-lb)  |       |
| 46         | FP-GDE-WIRE-PLATE-V1-R1                            | Wire Routing Plate                                    |                  |       |
| 47         | FP-PRO-FOAM-87*21-V1-R1                            | Wire Routing Plate Foam (70x21)                       |                  |       |
| 48         | FP-PRO-FOAM-87*32-V1-R1                            | Wire Routing Plate Foam (70x32)                       |                  |       |
| 49         | FP-PRO-FOAM-87*40-V1-R1                            | Wire Routing Plate Foam (70x40)                       |                  |       |
| 50         | FP-PRO-PLATE-STRIP-V1-R1                           | Wire Routing Plate Rubber Strip                       |                  |       |
| 51         | FP-GDE-WIRE-BASE-V1-R1                             | Wire Routing Plate Rubber Base                        |                  |       |
| 52         | FP-GDE-WIRE-SHIELD-V1-R1                           | Wire Shield   |                  |       |
| 53         | FP-SCW-BTN-M5*16-V1-R1                             | M5x16 Wire Routing Plate Mounting Screw               | 3 Nm (26 in-lb)  | L     |
| 54         | FP-CVR-MOTOR-FRONT-V1-R1                           | Front Motor Mount Cover                               |                  |       |
| 55         | FP-PRO-SHTV5-SKD-V1-R1                             | SHTLv5 Skid Plate Protector                           |                  |       |
| 56         | FP-PRO-SHTV5-DT-V1-R1                              | SHTLv5 Downtube Protector                             |                  |       |
| 57         | FP-PRO-SHTV5-CS-V1-R1                              | SHTLv5 Chainstay Protector                            |                  |       |
| 58         | FP-PRO-SHTV5-SS-V1-R1                              | SHTLv5 Seatstay Protector                             |                  |       |
| 59         | FP-PRO-SHTV5-UR-V1-R1                              | SHTLv5 Upright Protector                              |                  |       |
| 60         | FP-PRO-LL-50MM-V2-R1                               | Lower Link Protector                                  |                  |       |
| 61         | FP-BLT-FLT-M2.5*8-V1-R1                            | M2.5x8 Flat Head Charging Port Mounting Bolts         |                  |       |
| 62         | FRAME SIZE STICKER - XS/SM/MD/LG/XL                | Frame Size Sticker                                    |                  |       |
| Axles      |  |   |                  |       |
| NUMBER     | PART NUMBER  | DESCRIPTION   | TORQUE           | *     |
| 101        | 157MM THROUGH AXLE V5                              | 157mm UDH Rear Axle                                   | 15 Nm (11 lb-ft) | G     |
| 102        | -  | 12mm Axle Washer (Included w/ Axle)                   |                  |       |
| Bike Care  |  |   |                  |       |
| *          | PRODUCT TYPE                                       | RECOMMENDED PRODUCT                                   |                  |       |
| G          | Grease   | Motorex Bike Grease 2000                              |                  |       |
| L          | Thread Locker**                                    | Loctite Thread Locker #243 (or equivalent)            |                  |       |
| G/L        | Grease (Bolt Shaft) / Thread Locker (Bolt Threads) | See Above   |                  |       |
| A          | Anti-Seize   | Motorex Copper Paste                                  |                  |       |
| R          | Retaining Compound                                 | Loctite Retaining Compound #620 (or equivalent)       |                  |       |

\*\*Threadlocker should always be applied to the corresponding female threads for the bolt specified



### Shuttle LT Wiring Diagram

- The diagrams below will help illustrate how the wires are to be routed through the internal cable guides and how the handlebar switches are attached to the cycle computer.
- The routing shown below will help minimize the likelihood of pinching a wire when removing and installing the motor for maintenance purposes.

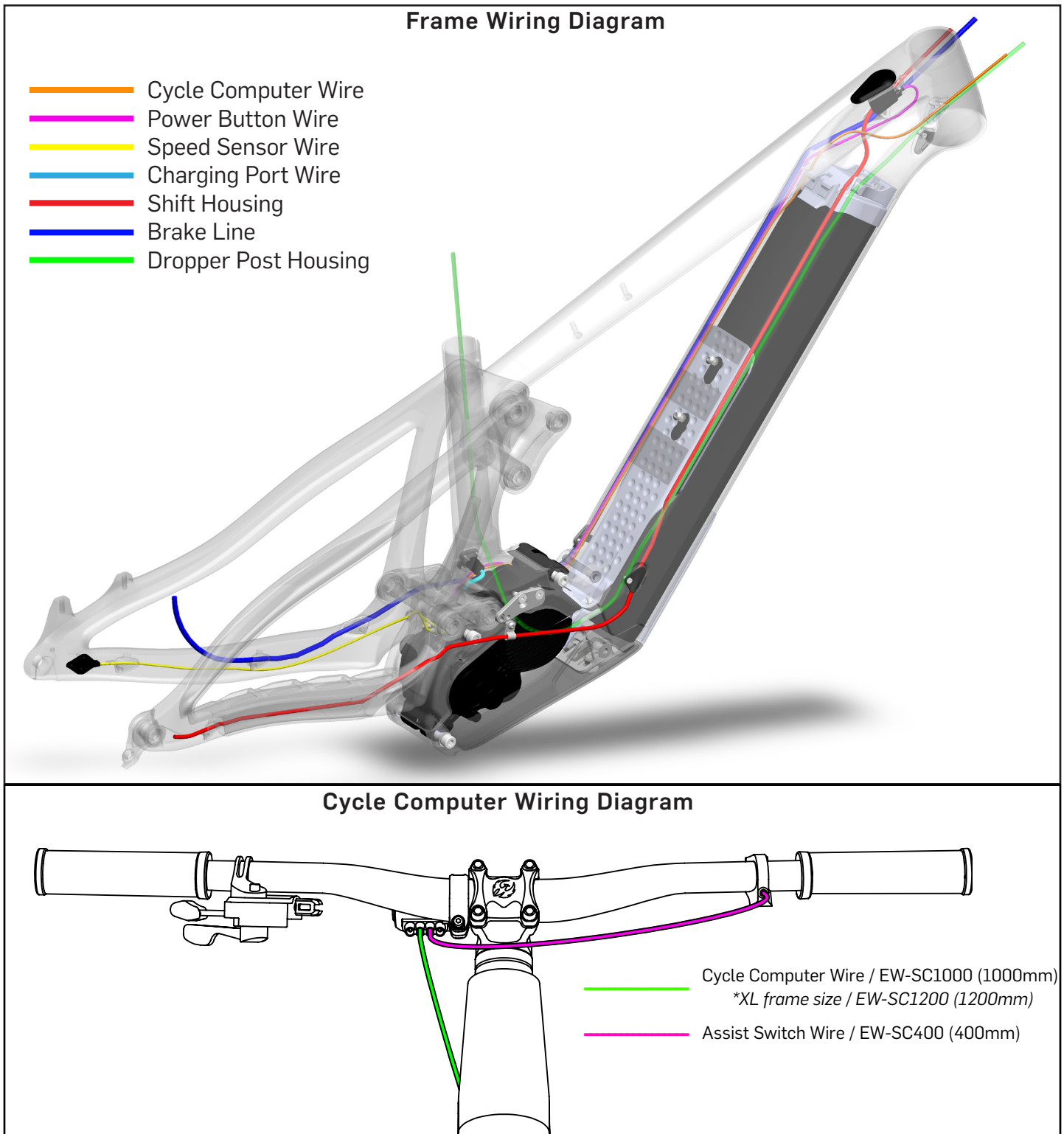

---

## **Bicycle Safety**

- This bike is not designed or equipped for use on public roads. Before it can be used on public roads it must be fitted with the legally prescribed equipment. It is designed to be used off-road, but not for competitions. The manufacturer and dealer accept no liability for damage resulting from any use beyond this definition and/or failure to comply with the safety information and instructions in this user guide. This applies particularly to, but not limited to, the use of this bike in competitions, overloading, and the failure to properly rectify faults. Intended use also includes conformance with the specified operating, service, and repair conditions in the user guide. Fluctuations in the consumption and power of the battery and a reduction of capacity with increasing age are common and technically unavoidable, and as such, do not constitute material defects.

## **Battery Safety**

- Batteries are subject to the dangerous goods regulations. Private users are permitted to transport them on the road without further conditions. If transported by commercial third parties (e.g. by air freight, logistics companies, or postal service) special conditions apply to packing and labeling. For questions about transporting batteries, please contact your local Pivot dealer.
- Damaged batteries must not be charged, used, or transported. They can explode and cause serious burns or fires. Gases can be released and irritate the airways. Ensure there is a supply of fresh air and consult a doctor in the event of discomfort. Liquid can escape and cause skin irritation. Avoid contact with this liquid, but in case of accidental contact, wash off with water. If the liquid gets into the eyes, flush out with water and seek medical attention.
- Batteries must not be submerged in water. There is a risk of explosion. Do not attempt to extinguish a burning battery with water, only the surrounding burning material. For burning batteries, use a Class D Fire Extinguisher. If it is possible to take the battery safely outside, smother the fire with sand. You do not need to worry that you are in danger when riding in the rain; the battery is protected from moisture and condensation.
- Clean the battery with a dry or, if at all, a slightly moist rag. Do not direct the water jet of a high pressure cleaner at the rechargeable battery or submerge the battery into water, as there is a risk of water entry and/or short-circuit.
- For more information on the proper handling of your rechargeable battery see the system instructions of your drive manufacturer.
- Charge your battery only with the supplied charger. Do not use the charger of any other manufacturer, not even when the connector of the charger matches your rechargeable battery. The rechargeable battery can heat up, catch fire or even explode!
- Keep the rechargeable battery and the charger out of the reach of children!
- We recommend that you charge your battery only during the day and only in dry rooms which have a smoke or a fire detector; but not in your bedroom. Place the battery during the charging process on a big, non-flammable plate made of ceramics or glass! Unplug the battery once it has been charged up.
- Keep the rechargeable battery and the charger away from moisture and water during the charging process to exclude electric shocks and short circuits.
- Do not use a rechargeable battery or a charger that is defective. If you are in doubt or if you have any questions, contact your Pivot dealer.

---

**Battery Safety (Continued)**

- Do not expose your battery or the charger to the blazing sun during charging.
- Do not charge any other electrical devices with the supplied charger of your Pivot e-bike.
- The drive is not approved for steam cleaning, high-pressure cleaning or cleaning with a water hose. The contact of the electrics or the drive with water can destroy the units. The individual drive components can be cleaned with a soft rag and neutral detergents. You may use a moist rag, but not excessive water. Keep the rechargeable battery dry and do not submerge it. Risk of explosion.
- Make sure your rechargeable battery does not show any damage, i.e. cracks, breakages or discolorations at the contact points. Do not use a battery with such damage. Bring a damaged battery to your Pivot dealer at once.
- Make sure your rechargeable battery is in sound condition. Do not open, disassemble or crush the battery. Risk of explosion!
- Make sure your rechargeable battery is not exposed to mechanical impacts.
- Keep your battery away from fire and heat. Risk of explosion!
- Batteries must not be short-circuited. Therefore store them in a safe storage area and make sure the battery is not short-circuited accidentally (e.g. with metal or another battery). In addition, rechargeable batteries must not be stored inappropriately, e.g. in a box or in a drawer where they can be short-circuited by other conductive materials or where they can short-circuit each other. Do not deposit any objects in the storage area (e.g. clothes).
- Make sure to use the battery only for the Pivot e-bike for which it is designed.
- Remove the rechargeable battery if you do not use your Pivot e-bike for a long period of time (e.g. during the winter season). Store the rechargeable battery in a dry room at temperatures between 5 - 20°C (41 - 68°F) . The state of charge should be 50 - 70% of the charging capacity. Check the state of charge if the rechargeable battery is left unused for more than two months and recharge it in between, if necessary, to 50%.
- The battery does not come charged and must be charged completely before the first use.
- When removing the charger from the outlet or the port, pull on the plug, not the cord.
- When charging the battery, plug the cord into the wall outlet first, and then into the battery.
- Be sure that the charger is on a flat and stable surface, when charging.
- Do not leave the battery fully depleted for an extended period of time. This will cause the battery to deteriorate and reduce the battery capacity.
- Keep the rechargeable battery and the charger away from moisture and water during the charging process to avoid electric shocks and short circuits.
- Keep the charger and battery out of reach of children.
- Do not use a battery or a charger that is defective. If you are in doubt, contact your Pivot dealer.
- If the rechargeable battery or the charger (or parts of it) must be replaced, only use original spare parts. Contact your Pivot dealer.
- Charge the battery at an ambient temperature of approximately 20°C (68°F). Therefore, before starting the charging, wait until the temperature of the battery has increased or decreased after a ride in cold or hot weather.
- Do not dispose of your rechargeable battery in the normal household rubbish! It must be disposed of according to battery disposal regulations. Therefore, sellers of new rechargeable batteries must provide collection of old batteries and appropriate disposal. If you are in doubt or if you have any questions, contact your Pivot dealer.
- When the battery is fully charged, remove the charger.
- Observe the notes on the respective labels on the rechargeable battery or on the charger.

**Shimano STEPS Drive System**

- Additional information regarding operation and functionality of the Shimano EP8 Drive System and to download the STEPS software and mobile apps to fully utilize the connectivity and customizability of the Shimano STEPS System visit: <https://bike.shimano.com/>

**Pivot Shuttle LT**

- For FAQs and additional technical documents regarding the maintenance of the Pivot Shuttle LT can be found at: <https://global.pivotcycles.com/products/shuttle-lt>

**Sources**

- Portions of this document have been sourced from information provided by Shimano. Additional end-user documentation can be found at: <https://bike.shimano.com/>



**Notes:**

.....

.....

.....

.....

.....

.....

.....

.....

.....

.....

.....

.....

.....

.....

.....

.....

.....

.....

.....

.....

.....

.....







---

**Notes:**

.....

.....

.....

.....

.....

.....

.....

.....

.....

.....

.....

.....

.....

.....

.....

.....





6720 South Clementine Court  
Tempe, AZ 85283

---

T +1 480 467 2920  
[info@pivotcycles.com](mailto:info@pivotcycles.com)  
[www.pivotcycles.com](http://www.pivotcycles.com)

---